

## 7500159 Getriebedeckeltausch

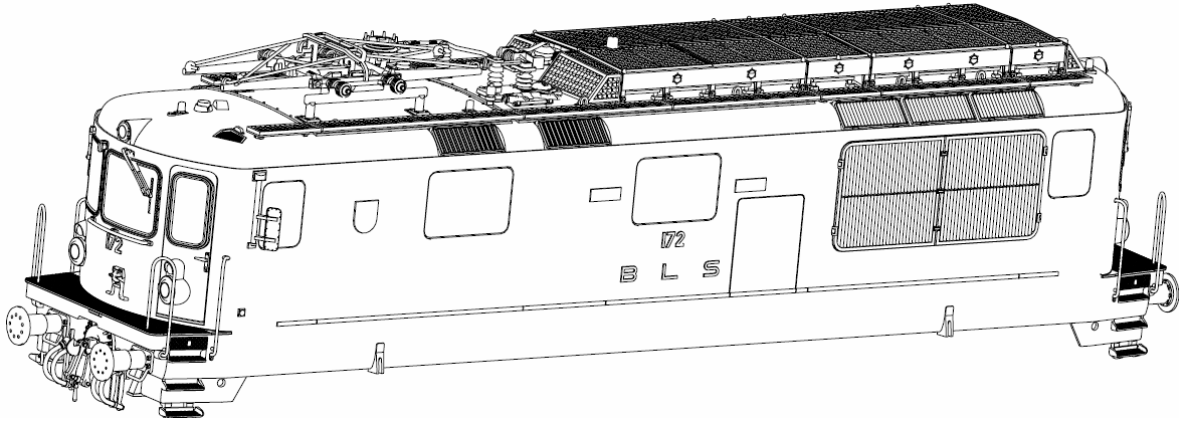

Gehäuse abnehmen + 4x M2 Schrauben entfernen

4x Kabel ablöten

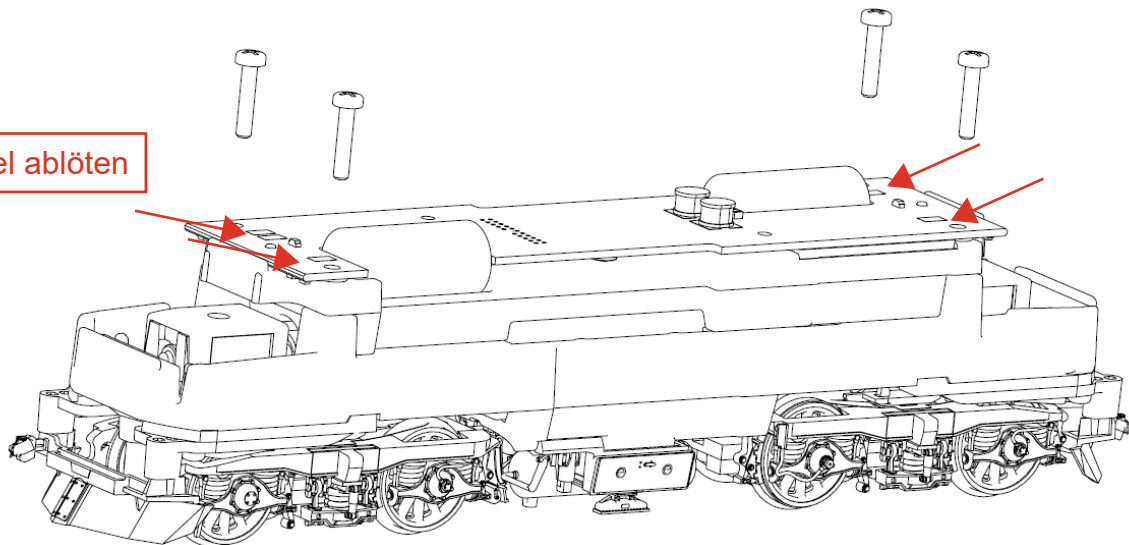

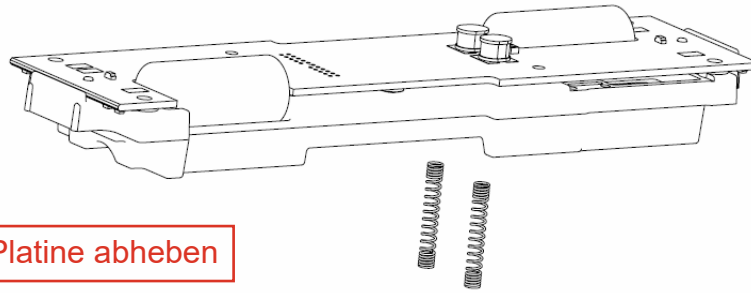

Zinkal Oberteil samt Platine abheben

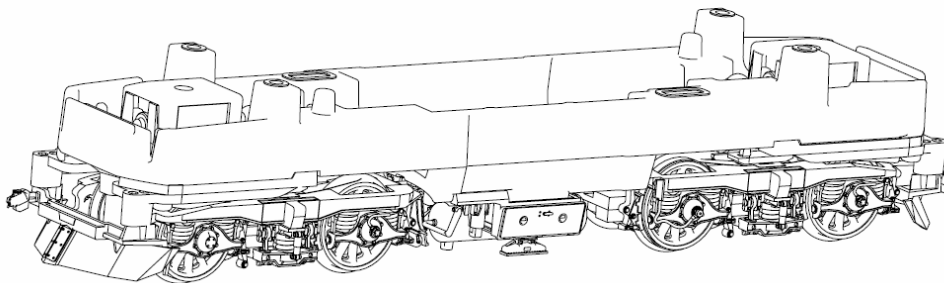
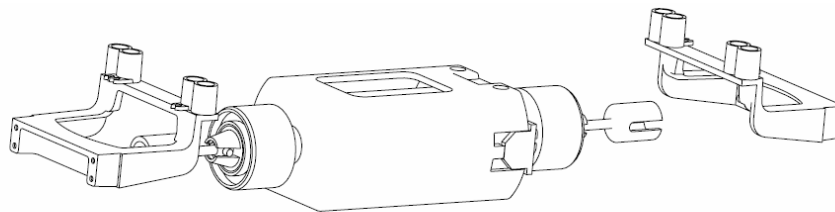
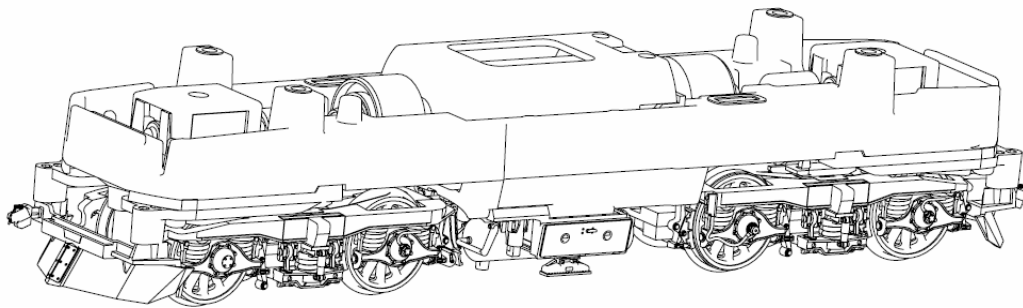

Motor, Kardanwellen und Lichtabdeckung entfernen



Schneckendeckel abhebeln



Schneckenbaugruppe herausnehmen



Ansatzschraube herausdrehen

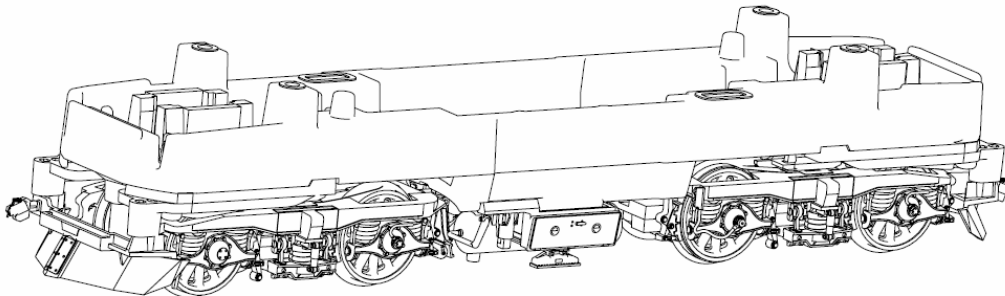

Drehgestelle herausnehmen

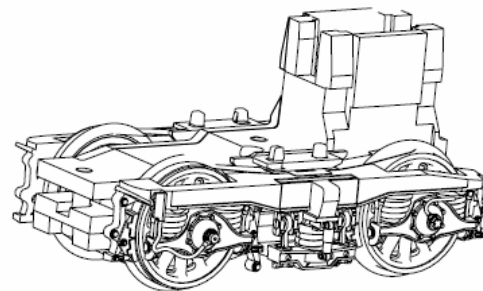
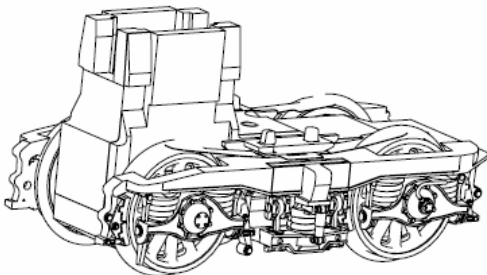

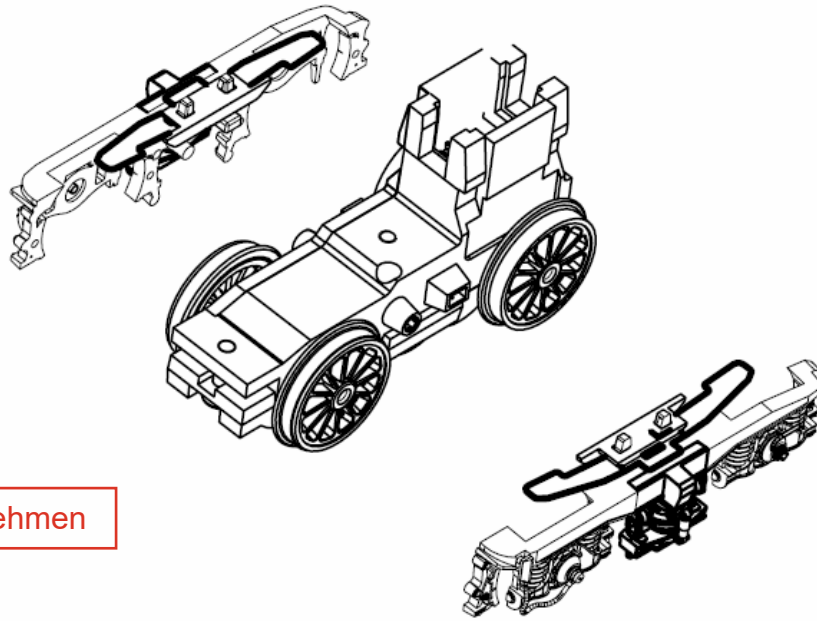

2x Blenden abnehmen



Schrauben herausdrehen

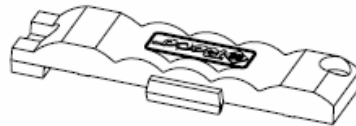

Getriebeboden und Radsätze herausnehmen

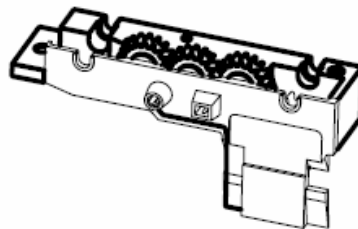
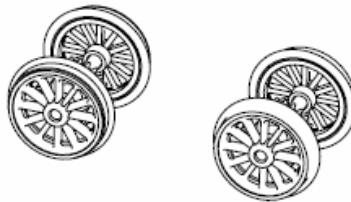

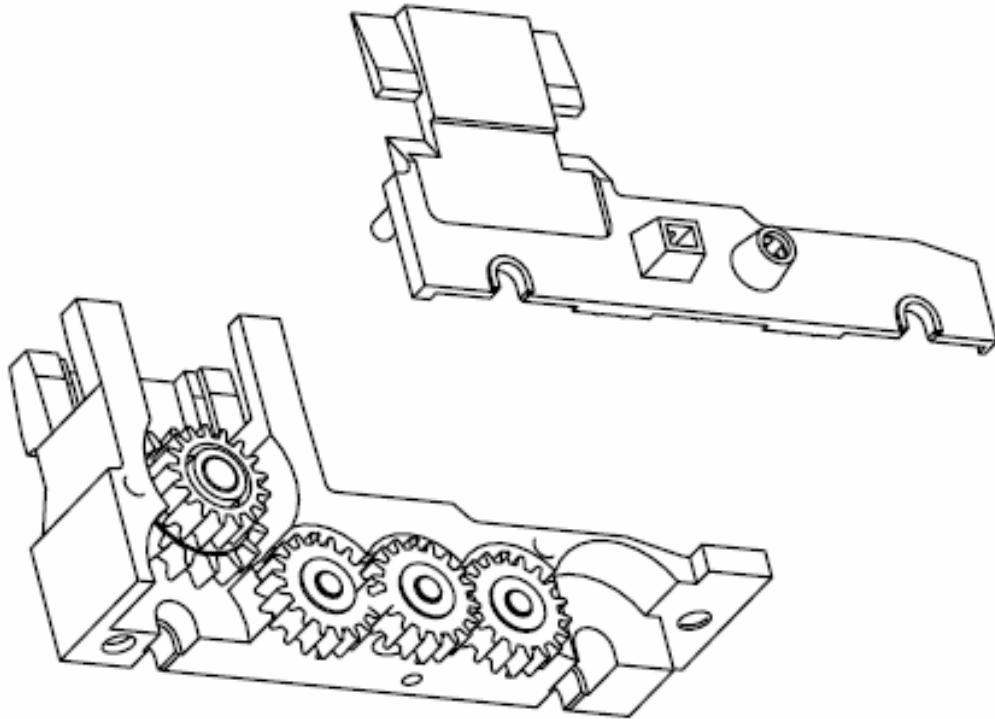

Getriebedeckel abnehmen und mit neuem Deckel tauschen

Danach alle abgenommenen Teile reverse wieder montieren